

Box Contents

- 1- Amplifier
- 1- Stereo RCA to mini adapter (UL60065 compliant)
- 1- 32V, 3.75 A power supply
- 2- Four-pin Euroblock connectors
- 3- Three-pin Euroblock connectors
- 1- Mounting bracket

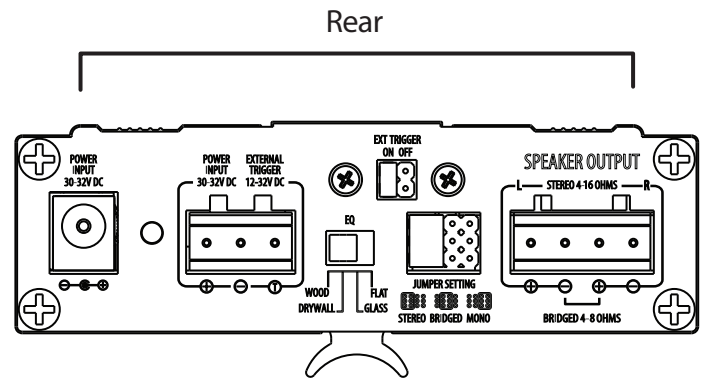
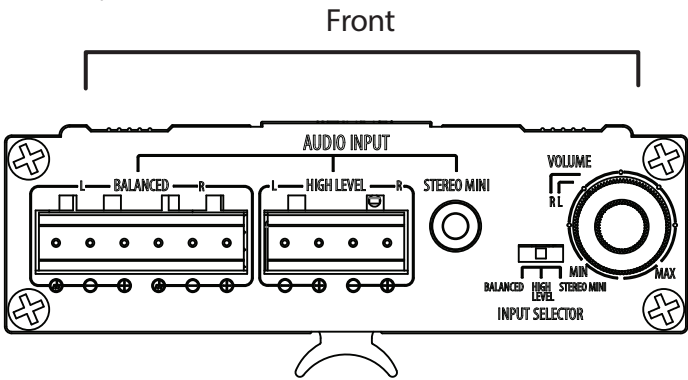
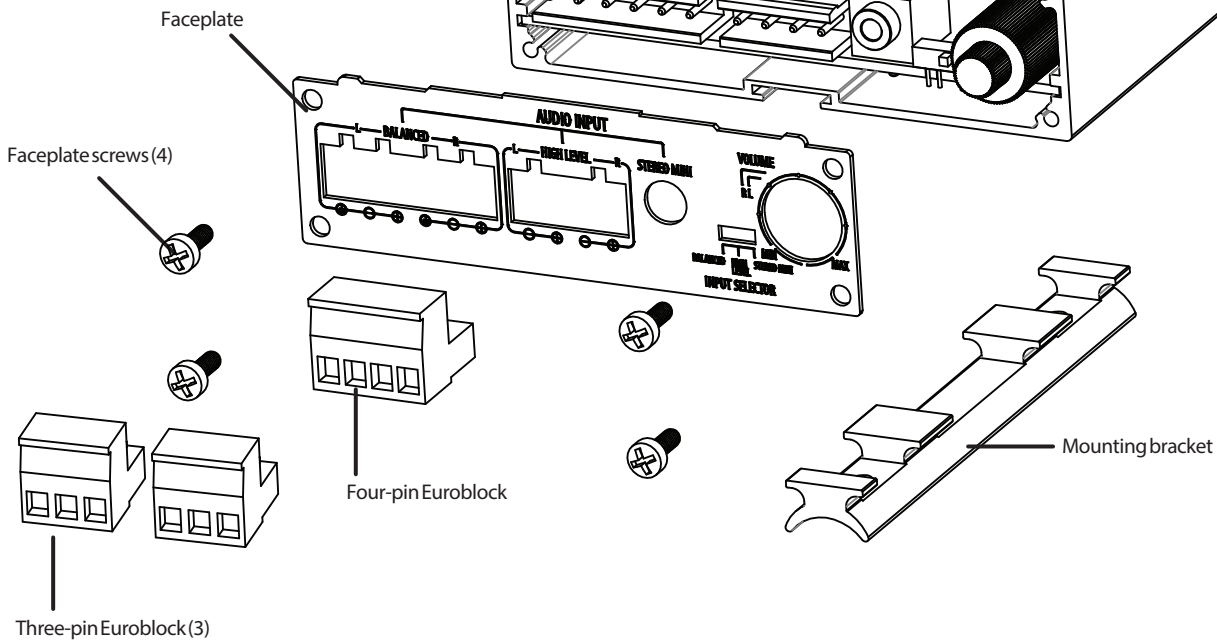
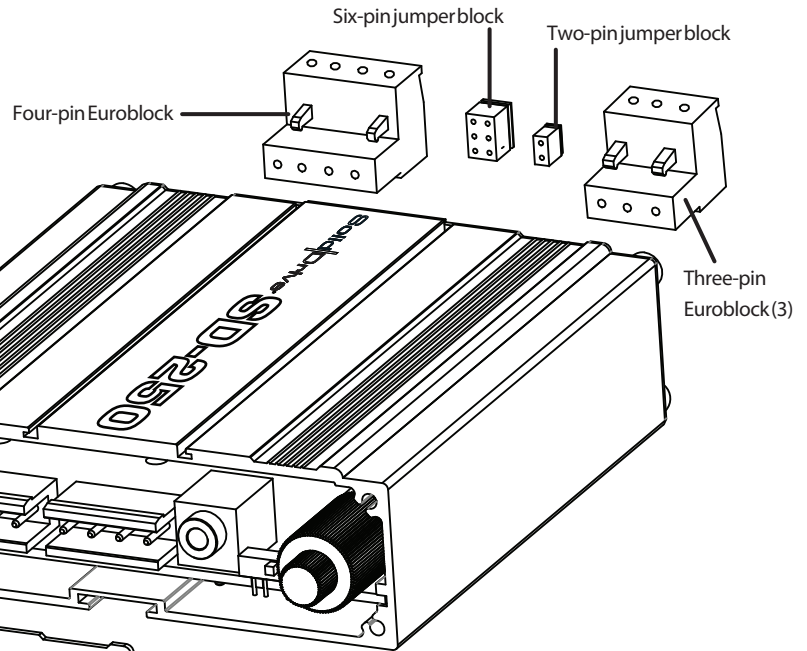

8650 College Boulevard, Overland Park, KS 66210

| 913.663.9770

| www.soliddrive.com

©2012 MSE Audio. All rights reserved. PNINS-SD-250 Rev10.24.12

Warning

SD-250 products must be installed by a professional audio installer/contractor. For safety and for optimum audio performance, installer must follow all directions issued by SoundTube for the SD-250.



Avis

Les produits SD-250 doivent être installés par un intégrateur de système audio professionnel. Pour des raisons de sécurité et de rendement audio optimal, l'installateur doit suivre toutes les directives d'installation des produits SD-250.

Important Safety Instructions

- 1) Read these instructions.
- 2) Keep these instructions.
- 3) Heed all warnings.
- 4) Follow all instructions.
- 5) Do not use this apparatus near water.
- 6) Clean only with dry cloth.
- 7) Do not block any ventilation openings. Install in accordance with the manufacturer's instructions.
- 8) Do not install near any heat sources such as radiators, heat registers, stoves, or other apparatus (including amplifiers) that produce heat.
- 9) Do not defeat the safety purpose of the polarized or grounding-type plug. A polarized plug has two blades with one wider than the other. A grounding type plug has two blades and a third grounding prong. The wide blade of the third prong are provided for your safety. If the provided plug does not fit into your outlet, consult an electrician for replacement of the obsolete outlet.
- 10) Protect the power cord from being walked on or pinched particularly at plugs, convenience receptacles, and the point where they exit from the apparatus.
- 11) Only use the attachments/accessories specified by the manufacturer.
- 12) Use only with the cart, stand, tripod, bracket or table specified by the manufacturer, or sold with the apparatus. When a cart is used, use caution when moving the cart/apparatus combination to avoid injury from tip-over.
- 13) Unplug this apparatus during lightning storms or when unused for long periods of time.
- 14) Refer all servicing to qualified service personnel. Servicing is required when the apparatus has been damaged in any way, such as power-supply cord or plug is damaged, liquid has been spilled or objects have fallen into the apparatus, the apparatus has been exposed to rain or moisture, does not operate normally, or has been dropped.

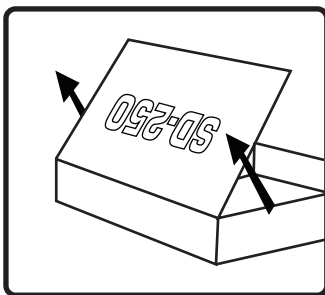

1. Unpack amplifier.

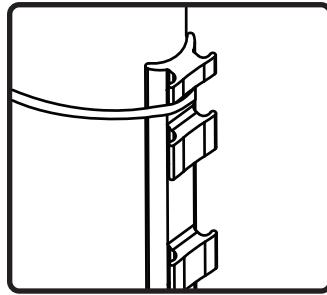

2. Attach mounting bracket to a secure pole or surface using screws or metal strapping.

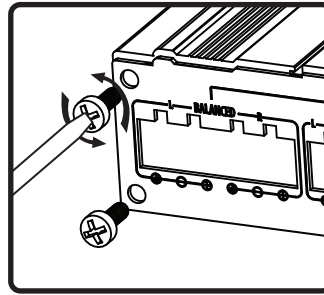

3. To attach mounting bracket, remove all faceplate screws from one side. Lift faceplate and set aside.

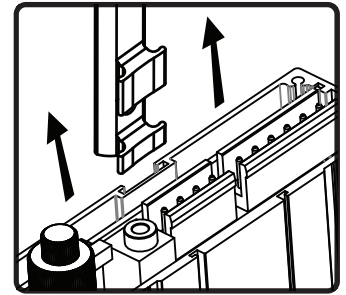

4. Slide mounting bracket into groove on bottom of amplifier enclosure.

Note: Follow steps 2-5 if using the mounting adapter. If not skip to step 6.

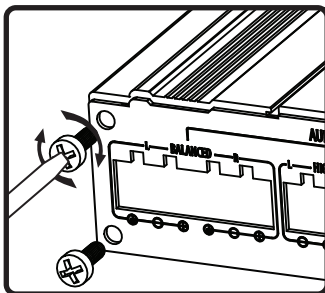

5. Replace faceplate and screws.

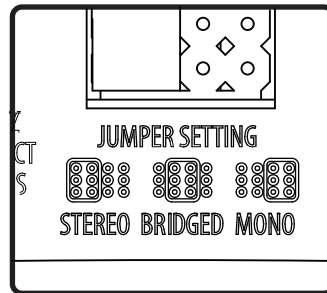

6. Select stereo, bridged or mono mode with the included jumper.

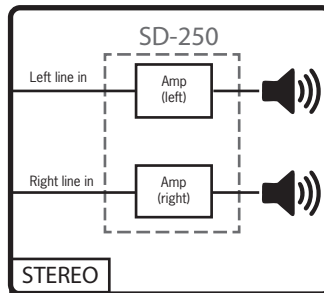

7a. In stereo mode, the left and right channels remain separate. The amp operates as a normal stereo amp.

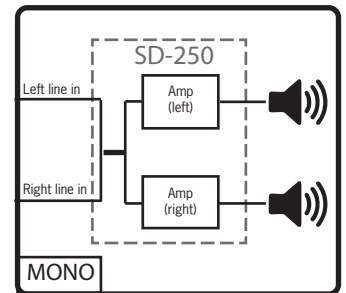

7b. In mono mode, the left and right inputs are combined internally and fed to both channels of the amp. The left and right channels both output the summed signal.

SD-250

Install Instructions For:
SD-250.

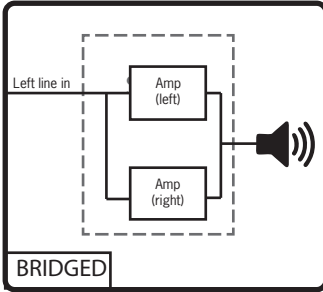

7c. In bridged mode, the amp becomes a mono block amp with just one input (left), and one output. The bridged amp is capable of 90w in to 4 ohms.

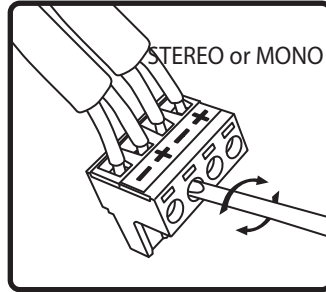

8a. Stereo and Mono: connect speaker wires to 4 pin Euroblock.

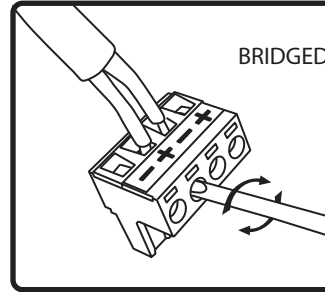

8b. Bridged: connect single pair of speaker wire to the center + and - terminals of 4 pin Euroblock. **DO NOT** use outside terminals.

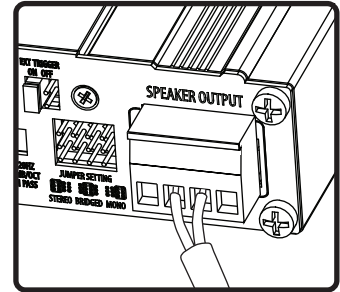

9. Connect speaker Euroblock to the SD-250.

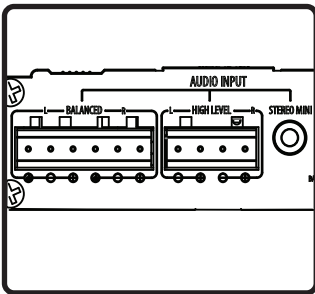

10. The SD-250 accepts audio sources via stereo mini, balanced Euroblock, or high level Euroblock on the front of the unit.

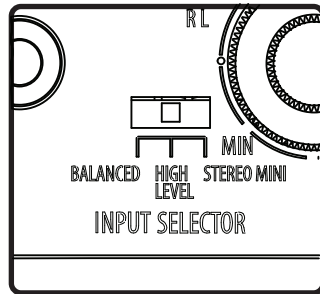

11. Select desired input via input selector switch located on the front of the SD-250.

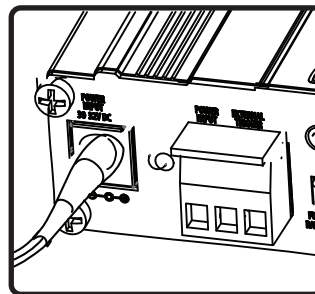

12. The SD-250 can be powered either by the hard wired Euroblock connector, or via barrel connector with the included power supply (shown above). Use a safety approved (UL/ETL, etc...) 32V 3.75A power supply.

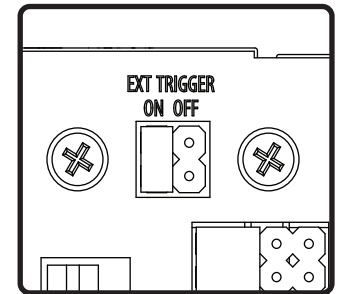

13a. The SD-250 can be turned on and off with an external 12v-32v DC trigger. To enable, move the jumper to "on."

Note: Amp comes equipped with auto-sensing circuit that idles down after 10 minutes without input signal. Unit powers back up when a signal is detected.

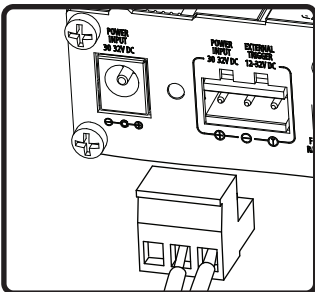

13b. If using external trigger, run the trigger positive wire into "T" and the trigger negative wire into "-" using the 3 pin Euroblock. Note: If using both external trigger and hard wired power, both negative wires will share the "-" Euroblock input.

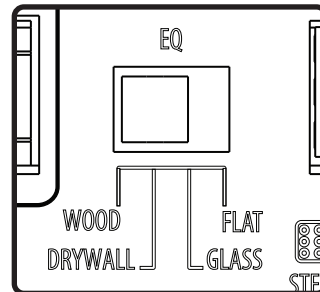

14. The SD-250 provides equalization settings for wood, drywall or glass SolidDrive installations. The EQ may also be set to flat response. Move the slide switch to the desired setting for your installation.

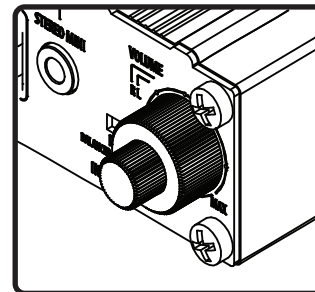

15. Adjust volume with knob on front of amplifier. Inner knob controls left channel and outer knob controls right channel.

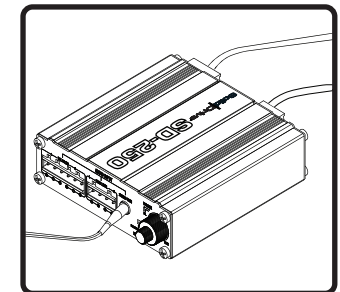

16. Done

FCC Notice

This device complies with Part 15 of the FCC Rules. Operation is subject to the following two conditions: (1) this device may not cause harmful interference, and (2) this device must accept any interference received, including interference that may cause undesired operation.

Le présent appareil est conforme aux CNR d'Industrie Canada applicables aux appareils radio exempts de licence. L'exploitation est autorisée aux deux conditions suivantes : (1) l'appareil ne doit pas produire de brouillage, et (2) l'utilisateur de l'appareil doit accepter tout brouillage radioélectrique subi, même si le brouillage est susceptible d'en compromettre le fonctionnement.

Changes or modifications not expressly approved by the party responsible for compliance could void the user's authority to operate the equipment.

This equipment has been tested and found to comply with the limits for a Class D digital device, pursuant to part 15 of the FCC Rules. These limits are designed to provide reasonable protection against harmful interference in a residential installation. This equipment generates uses and can radiate radio frequency energy and, if not installed and used in accordance with the instructions, may cause harmful interference to radio communications. However, there is no guarantee that interference will not occur in a particular installation. If this equipment does cause harmful interference to radio or television reception, which can be determined by turning the equipment off and on, the user is encouraged to try to correct the interference by one or more of the following measures:

- Reorient or relocate the receiving antenna.
- Increase the separation between the equipment and receiver.
- Connect the equipment into an outlet on a circuit different from that to which the receiver is connected.
- Consult the dealer or an experienced radio/TV technician for help.

Under Industry Canada regulations, this radio transmitter may only operate using an antenna of a type and maximum (or lesser) gain approved for the transmitter by Industry Canada. To reduce potential radio interference to other users, the antenna type and its gain should be so chosen that the equivalent isotropically radiated power (e.i.r.p.) is not more than that necessary for successful communication.

Conformément à la réglementation d'Industrie Canada, le présent émetteur radio peut fonctionner avec une antenne d'un type et d'un gain maximal (ou inférieur) approuvé pour l'émetteur par Industrie Canada. Dans le but de réduire les risques de brouillage radioélectrique à l'intention des autres utilisateurs, il faut choisir le type d'antenne et son gain de sorte que la puissance isotrope rayonnée équivalente (p.i.r.e.) ne dépasse pas l'intensité nécessaire à l'établissement d'une communication satisfaisante.

MPE Notice

To satisfy FCC RF exposure requirements, a separation distance of 20 cm or more should be maintained between the antenna of this device and persons during device operation. To ensure compliance, operations at closer than this distance are not recommended.

Les antennes installées doivent être situées de façon à ce que la population ne puisse y être exposée à une distance de moins de 20 cm. Installer les antennes de façon à ce que le personnel ne puisse approcher à 20 cm ou moins de la position centrale de l'antenne. La FCC des États-Unis stipule que cet appareil doit être en tout temps éloigné d'au moins 20 cm des personnes pendant son fonctionnement.

IC Notice

This device complies with Industry Canada licence-exempt RSS standard(s). Operation is subject to the following two conditions: (1) this device may not cause interference, and (2) this device must accept any interference, including interference that may cause undesired operation of the device.

Le présent appareil est conforme aux CNR d'Industrie Canada applicables aux appareils radio exempts de licence. L'exploitation est autorisée aux deux conditions suivantes : (1) l'appareil ne doit pas produire de brouillage, et (2) l'utilisateur de l'appareil doit accepter tout brouillage radioélectrique subi, même si le brouillage est susceptible d'en compromettre le fonctionnement.
